



DEA How to Stash Items

*This is a handbook (allegedly) written by the U.S. federal Drug Enforcement Agency, for use in seminars teaching law enforcement how to conduct searches of suspect property. Whether official or not, this should help lend some insight into what law enforcement will be looking for, and where you should not be hiding evidence or illegal contraband.

Drug Concealment in the Home

- Under or in the mailbox
- In flower pots or window boxes
- Inside hollow doors (removable tops)

INSIDE HOLLOW DOORS (REMOVABLE TOPS)

VELCRO OR MAGNETS

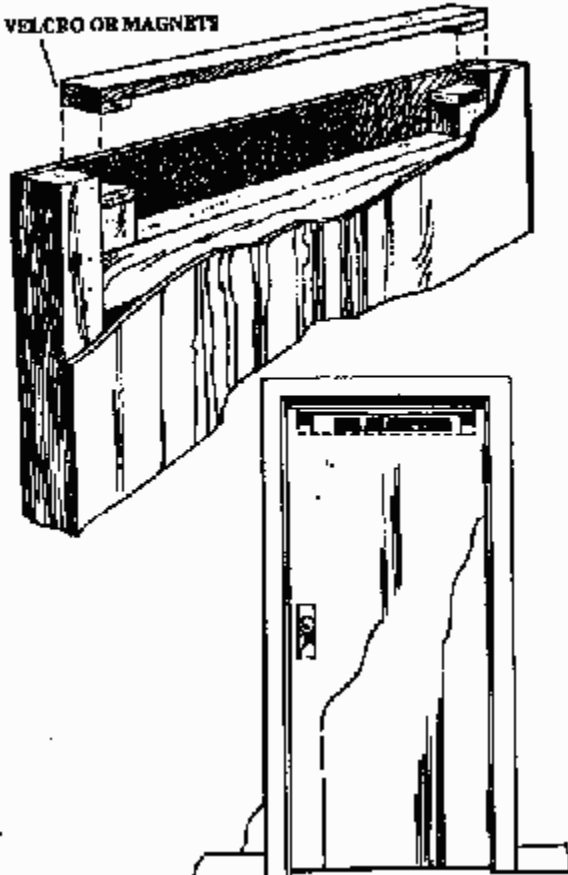

- Inside door chimes and door bells
- Behind plumbing inspection doors
- In doorknobs
- In or under dog collars
- Hanging out windows
- In rolled-up window shades
- On or under window ledge next door
- On top of window, door sills, molding
- In fire or water hoses
- In or on cellar beams
- Taped to movable clothesline
- Behind exterior brick near window
- Inside fuse boxes
- In conduit from fuse box
- Inside fire alarm bell
- In dog houses
- In rain gutters or drain spouts
- Inside abandoned plumbing
- In attic insulation
- Inside or under furnace
- In hollowed-out tree
- Within fuel of oil heaters
- Under lip ring of plastic trash cans
- Under tile steps of backyard
- Under fence post tops
- Inside rabbit hutch
- In pay telephone coin return
- In telephone base and handle

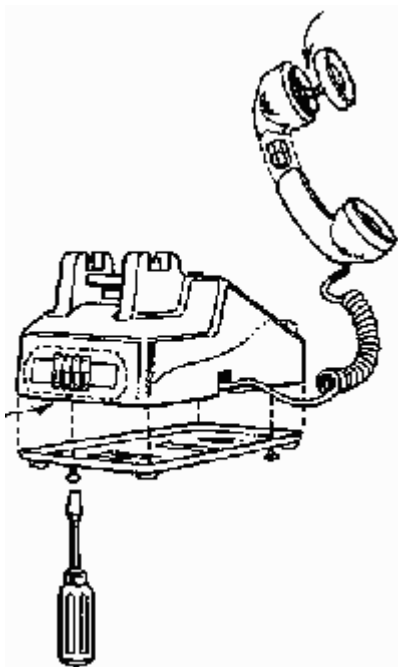

- Behind wall phones
- Under telephone name plate
- In clothesline pipe
- Refrigerator:
- Inside fruit containers
- In eggs
- In mayonnaise
- Under food
- Taped under door
- Inside motor compartment
- LSD on food items
- Inside garbage disposal unit
- Behind electric baseboard heaters
- Inside string mop
- Under ironing board cover
- On bottom of dog food bag
- Bottom half of double boiler
- In ironing board legs
- Under toaster tray
- Inside plastic rolling pin
- Inside knife handles
- In clock
- In hot-air ducts
- In stove pipes
- In garbage bags
- In bromo seltzer, cough syrup, prescription drug bottles
- In baked bread, cookies, brownies and candy bars
- Built inside room dividers
- Behind kick plate of sink cabinets
- In stove insulation, exhausts, and drip pans
- Within tea bags
- Above acoustic tile ceilings
- Inside tinfoil tube
- In salt and pepper shakers
- In waxed-paper dispensers

- In spice jars
- In all kitchen canisters and containers
- In hollowed fruits or vegetables
- In or on chandelier
- Within agitator of clothes washer
- On, behind, or above Venetian blinds
- In florescent light tubes
- Behind wall and ceiling light fixtures

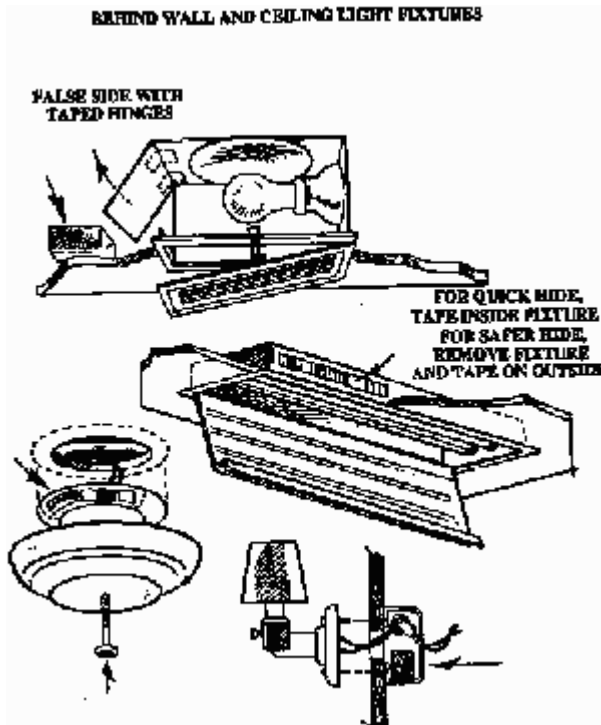

- Inside light housing
- Behind light switches
- Inside or behind electric sockets
- In removable air-conditioning registers
- In range hood and filter
- Inside deep well fryers
- Behind baseboards
- Inside flashlights
- Inside douche bags
- Within sanitary napkins and in box
- In razor blade dispenser
- In hollowed-out flashlight batteries
- Inside talcum powder, cold cream, and Vaseline containers
- In electric toothbrush holder
- In toothpaste tubes
- In clothes hamper
- Hung behind curtains
- Inside false ceilings and chimneys
- In or behind sink traps
- In bases of lamps
- Under washbowl, sink, or tub
- At bottom of pet litter box
- Inside hollow curtain rods, shower curtain rods, and within closet rods
- Under false bottom on radiator covers
- Inside toilet tanks

- Inside toilet bowl float

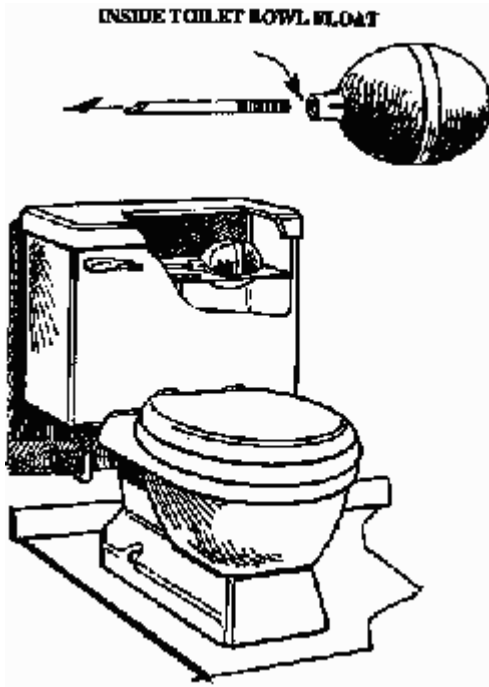

- Taped to top of toilet bowl
- Within false aerosol cans
- In Band-aids and Band-aid boxes
- Inside stick deodorant containers
- Within hollow soap bars

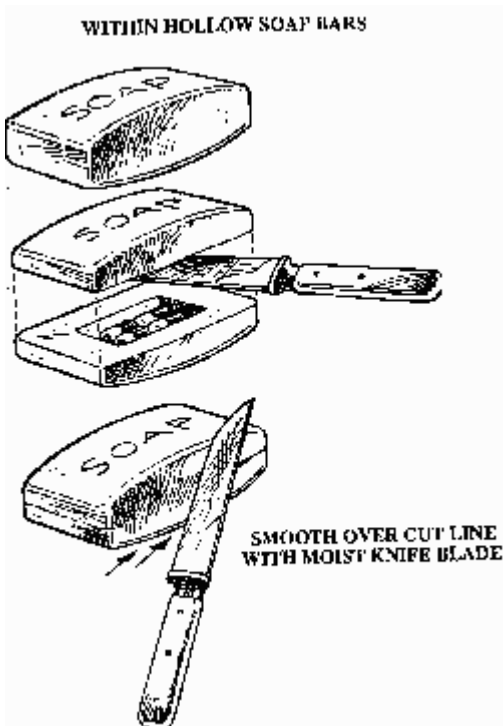

- Under panel or parquet floors
- Inside toilet paper roll
- In clothes-pin bag

- Inside hollow handle of toilet bowl brush
- In after shave, cologne, or cosmetic bottles
- Inside shaving brush handles
- In hair dryer
- In shower nozzle head
- In razor blade disposal box
- In or behind legs of old-style bath tub
- Closet clothing:
 - In waistbands
 - In pens
 - In sleeves
 - In hat bands
 - In shoes
 - In gloves
- Behind picture frames, posters, and mirrors
- In mattresses and box springs frames
- Inside pillows
- Under carpets
- In seams of field cots and hollow cap of cot legs
- Inside hassocks
- Inside and under wigs
- Behind walls
- In hollow bedposts
- In furniture upholstery
- In golf bags
- In toys, stuffed animals, and games
- Inside child's bank
- Taped in dresser and behind drawers
- Inside concealed magnet boxes
- Inside zippered cushions
- Inside pipe rack stand
- In false-bottomed baby carriage and cribs
- In footlockers
- In hem of drapes and curtains
- In hidden drawers in tables
- Inside letters
- In dolls
- In art kits
- Bible (hollow cover) and other books (hollow pages)

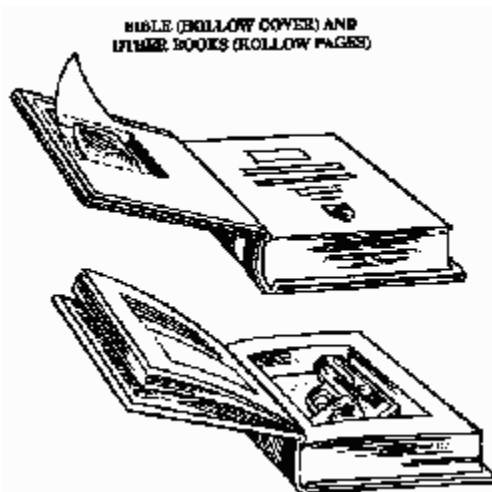

- Inside jewelry boxes
- Mixed with tobacco
- Taped to hat or shoe boxes

- LSD on or in blotter
- Inside tube or barrel of air rifle
- In bird cage
- In typewriters and typewriter covers
- Inside hollow chess players and boards
- Inside hollow canes and umbrellas
- In fireplace ash clean-out bin
- In drops of graph paper
- Inside base of rabbit antenna
- Inside TV set
- Inside TV antenna
- Inside picture tube or altered components
- Within hollowed-out pad of paper
- In surf boards, skis, and other sports equipment
- Inside Christmas tree decorations
- Inside handle of vacuum cleaners
- Inside and behind vacuum cleaner bag
- In tool box
- In shoe polish container and equipment
- In 35mm film cans
- Inside cameras
- In record albums
- In fish tanks
- Inside patch trap of antique rifle
- Inside rifle cartridges and shotgun shells
- Behind rifle butt plates
- Inside carpenter's toolbox
- Inside candlestick holders
- Inside ceramic and clay figurines
- Inside rolled-up newspaper
- Inside trophies
- In test tubes
- Inside crucifix
- Inside sealed and open cigarette packages
- Inside stairway posts

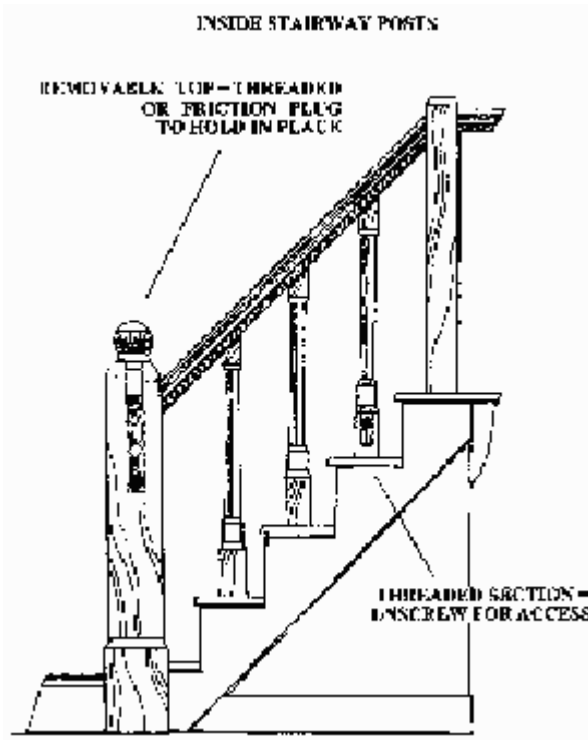

- Inside transistor radio
- Inside speakers
- Inside other stereo components
- In musical instruments and cases

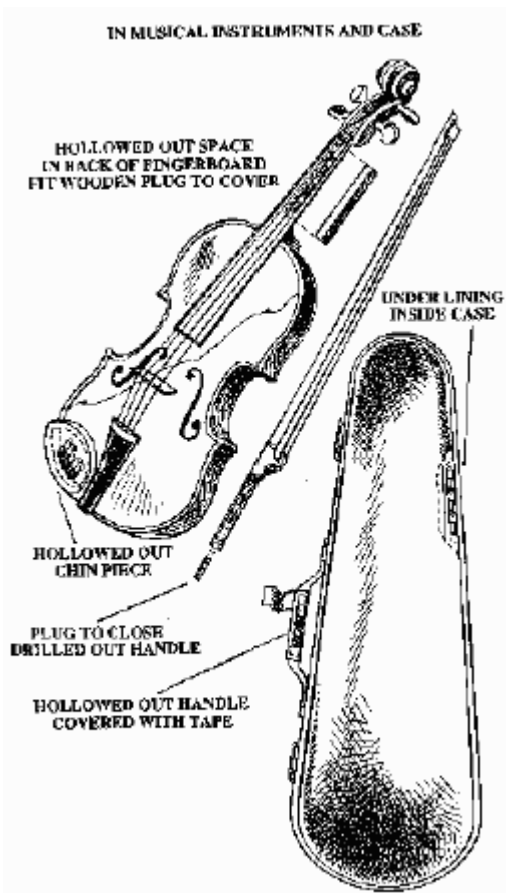

Concealment in an Automobile

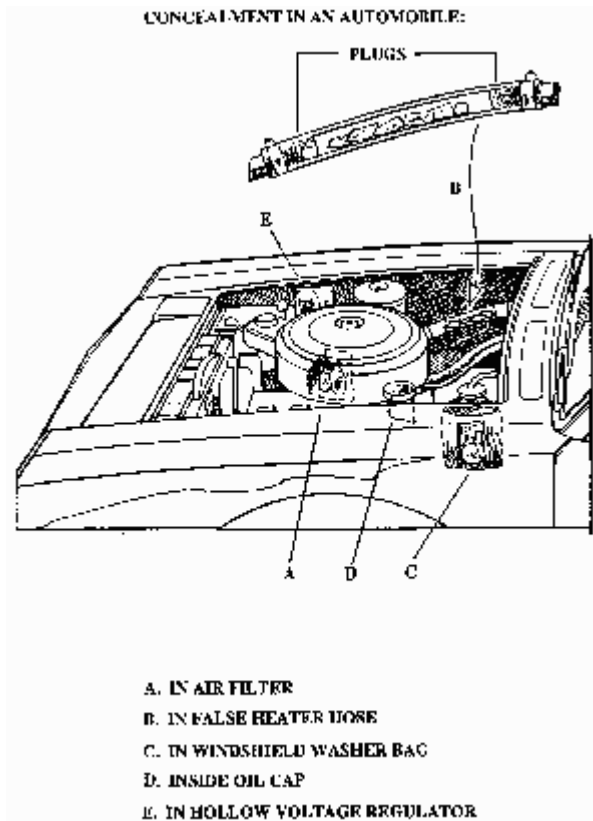

- Inside horn
- In air filter
- In false heater hose
- In heater
- In false battery
- In oil filter
- In windshield washer bag
- In carburetor
- Inside oil cap
- In false dual muffler
- In hollow voltage regulator
- On top of gas tank (suspended or concealed in compartment)
- Under rocker panels
- Tied to axles
- Underside of fender
- In tail pipe
- In insulation under hood
- Under chrome
- Behind Volkswagen battery box
- Inside trunk lids
- Inside tubing on roof racks
- Inside tubing of surfboard or ski rack
- Under tire air valve caps
- Taped behind bumper
- In antenna base
- Taped to rolled-down window
- Behind license plate
- Attached to frame of car
- Behind headlights and taillights

BEHIND HEADLIGHTS AND TAILLIGHTS

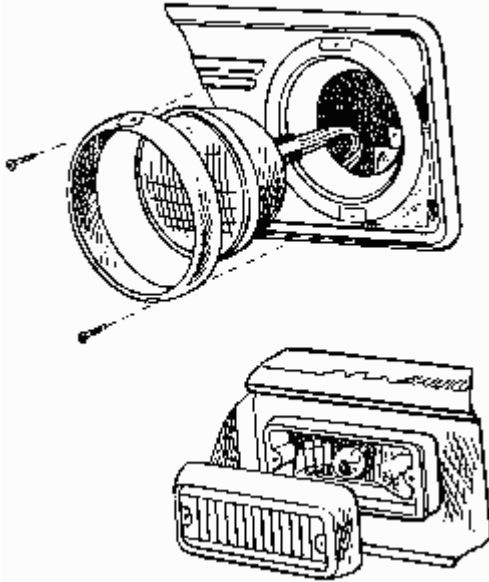

- Within hub caps
- In picnic jug in trunk
- In double roof of surplus police cars
- Within spare tire and tire well
- In convertible top
- In trunk
- In fuse box
- Under false bottom of trunk beds
- In cigarette lighter
- Under floorboards
- Under front seat
- Under back seat
- Within vents (air and heater)
- In glove compartment - top of compartment or trap
- Within door
- Behind radio speaker grill
- In shift knob
- In steering column
- In dome light
- In and under ashtrays
- Inside key case
- In service station travel kits
- Under brake and gas pedals
- In or behind sun visors
- Under carpet
- Behind or within false radio
- Inside a hide-a-key container
- Pill vials
- Under floor mats
- Within upholstery
- Behind instrumental panel
- Under ornamental objects on dashboard

BEHIND INSTRUMENT PANEL AND
ORNAMENTAL OBJECTS ON DASHBOARD

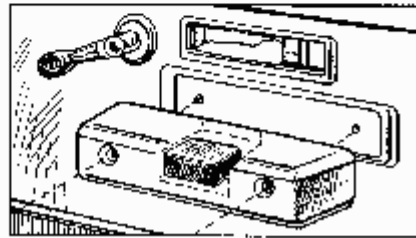
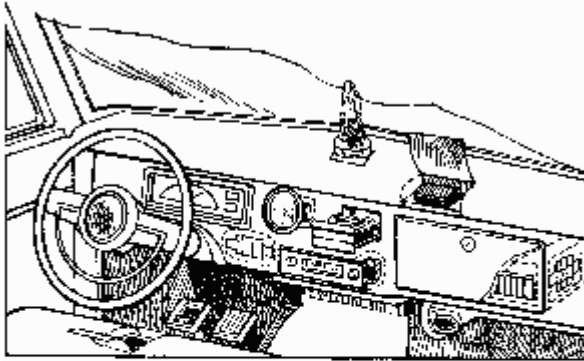

WITHIN ARM RESTS

- Within compartments under floor of older VWs and Jeeps
- Inside floor consoles
- Inside dash knobs
- Within arm rests
- Inside flashlight
- Inside toolbox
- Inside light sockets

Concealment on a Motorcycle

MOTORCYCLERS:

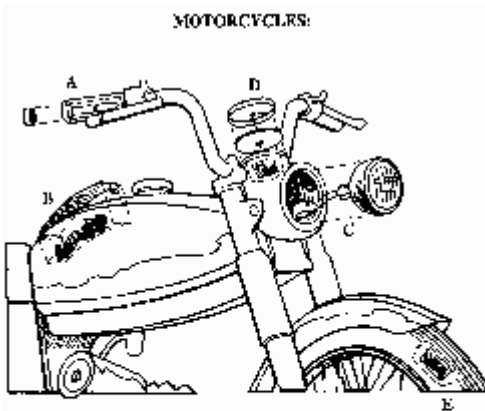

- A. INSIDE HANDLEBAR TUBING
- B. COMPARTMENT IN CUSTOM GAS TANK
- C. BEHIND HEADLIGHT
- D. BEHIND INSTRUMENT GAUGES
- E. INSIDE TIRES

- Behind taillights
- Under seats
- Inside handlebar tubing
- Inside battery box

- In toolbox
- Rolled up inside sleeping bag or other carried items
- Concealed compartment in custom gas tank
- Inside lining of motorcycle helmet
- In concealed pockets in padded clothing
- Behind headlight
- Behind instrument gauges
- Inside tires

Concealment on the Person

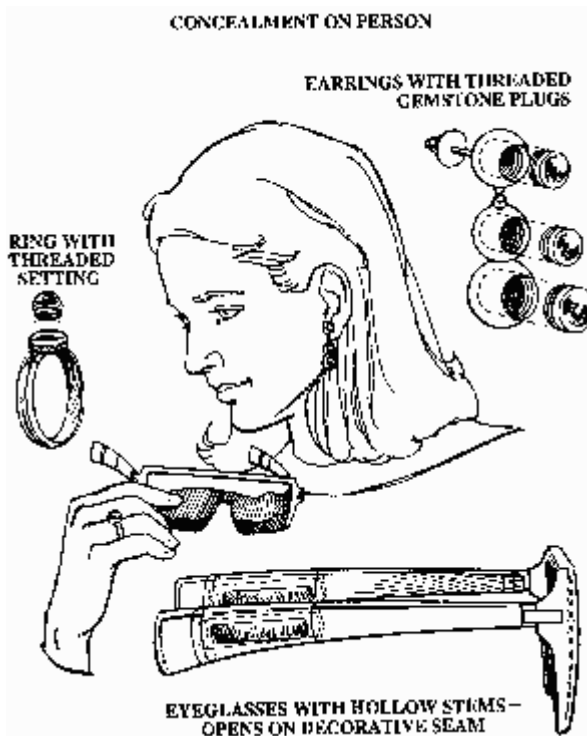

- Inside false caps on teeth
- Swallowed with string tied to teeth
- Under false teeth
- Loose in mouth
- Behind or in ears
- In glass eyes
- In nose
- Taped under breasts
- In brassiere
- Under Band-aids and bandages
- Within rectum
- Within vagina
- Between cheeks of buttocks
- Under foreskin of penis
- Inside feces bag
- In false leg, arm, foot, etc.
- In or behind woman's barrettes
- Under processed hair, hair buns, or wigs
- In hearing aid mounted on eyeglasses or within ears

CONCEALMENT ON THE PERSON:



A. IN PLASTER CAST

B. IN NON-SUPPORTING SECTION OF CRUTCH

- Under hat bands
- In hats
- Under military cap insignia
- Under lapel and shoulder patches
- Behind campaign ribbons and uniform brass
- Hasish in love beads
- In fountain pens
- In money belts, slit or zippered
- In tie pins, clasps, and cuff links
- In lining of clothing
- Within false buttons
- Under lapels of jacket and coats
- Inside back of watch
- In pockets
- In eyeglass case
- In corsets
- In tie knot of tie and handkerchiefs
- Jockstraps
- Wallet
- In hollow belt buckles
- Inside fly flap of trousers
- Pinned to shorts
- In swimming trunks
- In male or female girdle
- Inside cuffs or waistbands
- In socks and shoes
- In baby's diapers
- In lipstick tube
- In tobacco tins and pouches

- In cigarette package
- In cigarette lighters
- Inside hollowed-out crutches
- In hollow end of cane or umbrella

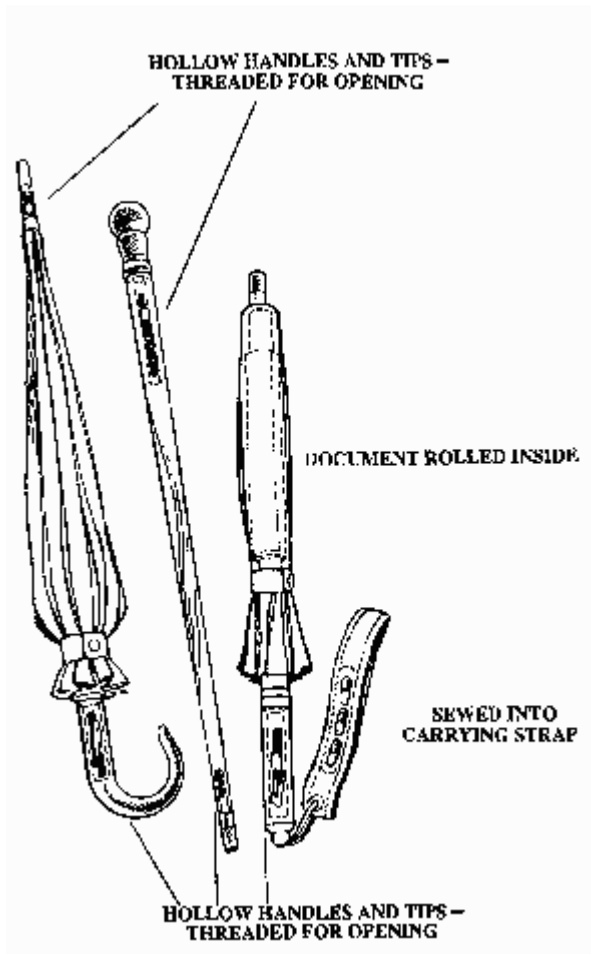

- In Thermos jug cavity or lining
- In canteens
- In addressed envelopes
- Within liners of luggage